

Specification

EW620 I/O Series

EW62T5521

EW62T5521 (2-Phase Bipolar Stepping Motor Driver, 24Vdc 1A)

Specification

Table of Contents

Table of Contents	2
History	3
1. ENVIRONMENT SPECIFICATION	4
2.EW62T5521(2-Phase Bipolar Stepping Motor Driver, 24Vdc 1A)	5
2.1. EW62T5521 Specification	5
2.2.EW62T5521 Wiring Diagram.....	7
2.3.LED Indicator.....	9
2.3.1.Channel Status LED	9
2.4.Configuration Parameter Data.....	11
2.5.Mapping data into the image table	13
2.6. Application Commands.....	15
2.7. How to use position table function.....	24

Specification

1. ENVIRONMENT SPECIFICATION

Environmental specification	
Operation Temperature	-40°C to 60°C
Storage Temperature	-40°C to 85°C
Relative Humidity	5% to 90% Non-condensing
Operating Altitude	2,000m
Mounting	DIN Rail
General specification	
Shock Operating	IEC 60068-2-27
Vibration Resistance	Based on IEC 60068-2-6 Sine Vibration <ul style="list-style-type: none"> - 5 ~ 25Hz : ±1.6mm - 25 ~ 300Hz : 4g - Sweep Rate : 1 Oct/min, 20 Sweeps Random Vibration <ul style="list-style-type: none"> - 10 ~ 40 Hz : 0.0125 g²/Hz - 40 ~ 100 Hz : 0.0125 → 0.002 g²/Hz - 100 ~ 500 Hz : 0.002 g²/Hz - 500 ~ 2000 Hz : 0.002 → 1.3 x 10⁻⁴ g²/Hz - Test time : 1hrs for each test
Industrial Emissions	EN 61000-6-4/A11 : 2011
Industrial Immunity	EN 61000-6-2 : 2005
Installation Pos. / Protect. Class	Variable/IP20
Product Certifications	CE/UL

Specification

2. EW62T5521(2-Phase Bipolar Stepping Motor Driver, 24Vdc 1A)

2.1. EW62T5521 Specification

Items	Specification
Digital Input	
Number of Channel	4 Points, Sink type
Indicators	4 Green Terminal Input LEDs
ON-state Voltage	24Vdc nominal Min. 10Vdc to Max. 32Vdc(TBD)
Minimum OFF-state Voltage	7.6Vdc maximum(TBD)
ON-state current	6.4mA maximum/point @32Vdc(TBD)
Input Signal Delay	OFF to ON : 0.3ms Max @ 24Vdc(TBD) ON to OFF : 0.3ms Max @ 24Vdc(TBD)
Nominal Input Impedance	5.4K Ω
Encoder mode	Incremental Encoder Support
General specification	
Power Dissipation	Max. 120mA @ 5.0Vdc(TBD)
Isolation	I/O to Logic : Isolation
Field Power	Supply voltage : 24Vdc nominal Voltage range : 18~28.8Vdc, Power Dissipation : Max. 35mA @ 24Vdc (TBD)
Wiring	I/O Cable Max. 2.0mm ² (AWG 14)
Weight	60g
Module Size	12mm x 99mm x 70mm,
Environment Condition	Refer to 'Environment Specification'
Items	Specification
Stepper Motor Driver Power Element	
Amount	1 Stepper motor
Motor Type	2-Phase Bi-polar
Rated Voltage	24Vdc nominal Min. 18Vdc to Max. (TBD) 32Vdc)
Output Current	Max. 1A @-40°C ~ 60°C (TBD)
Step resolution	1/16 microstep
Operation Modes	Instant Command Mode Position Table Mode

Specification

Function Modes	Position(absolute/relative), Set Point Change, etc.
Protection	Over current / Over voltage(TBD) Reverse voltage protection

Specification

2.2. EW62T5521 Wiring Diagram

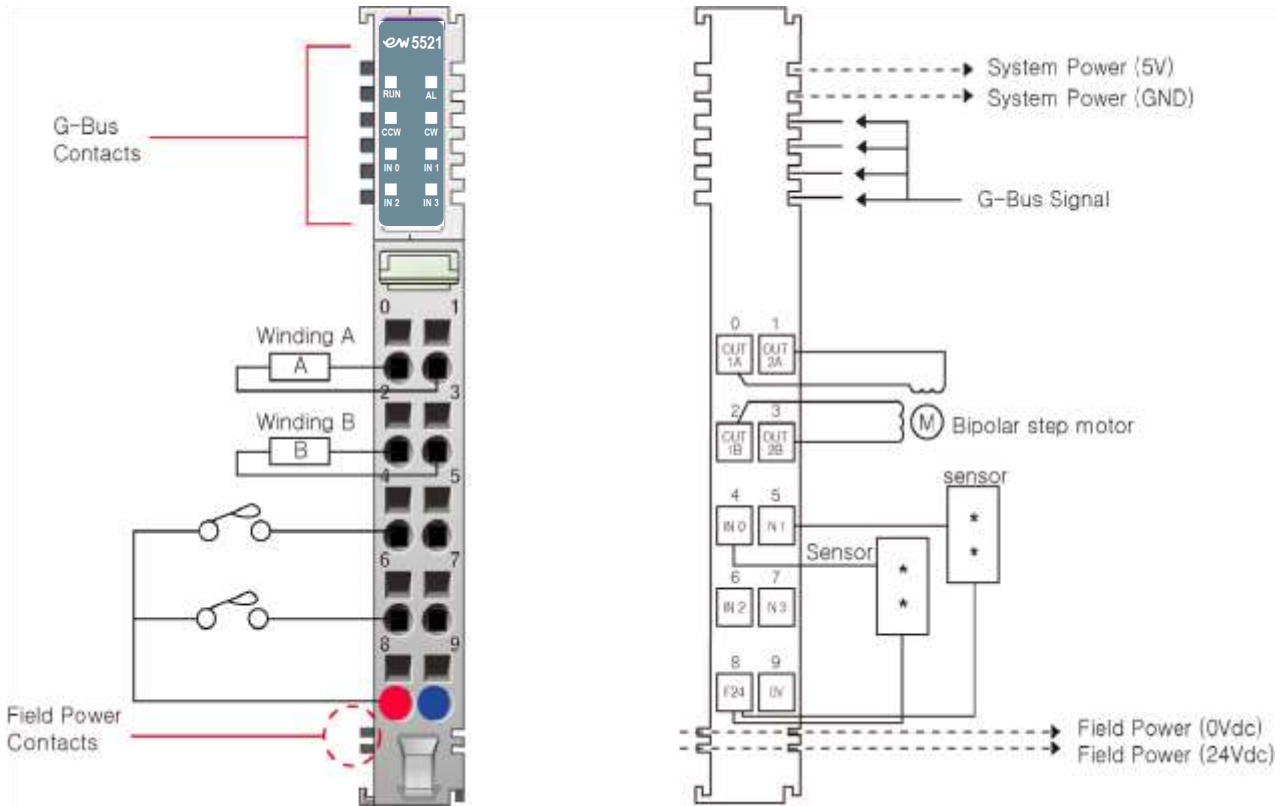

Pin No.	Signal Description		Signal Description		Pin No.
0	Motor Out1_A		Motor Out2_A\		1
2	Motor Out1_B		Motor Out2_B\		3
4	Input Channel 0		Input Channel 1		5
	Digital Input	Encoder Mode	Digital Input	Encoder Mode	
	Limit +	Enc Aph	Limit -	Enc B	
6	Input Channel 2		Input Channel 3		7
	Digital Input	Encoder Mode	Digital Input	Encoder Mode	
	End +	Enc Zph	End -	Trigger Input	
8	Field Power 24V		Field Power 0V		9

*** Warning : Do not connect or disconnect a motor while the driver is energized.**

2.3. Function Command

Specification

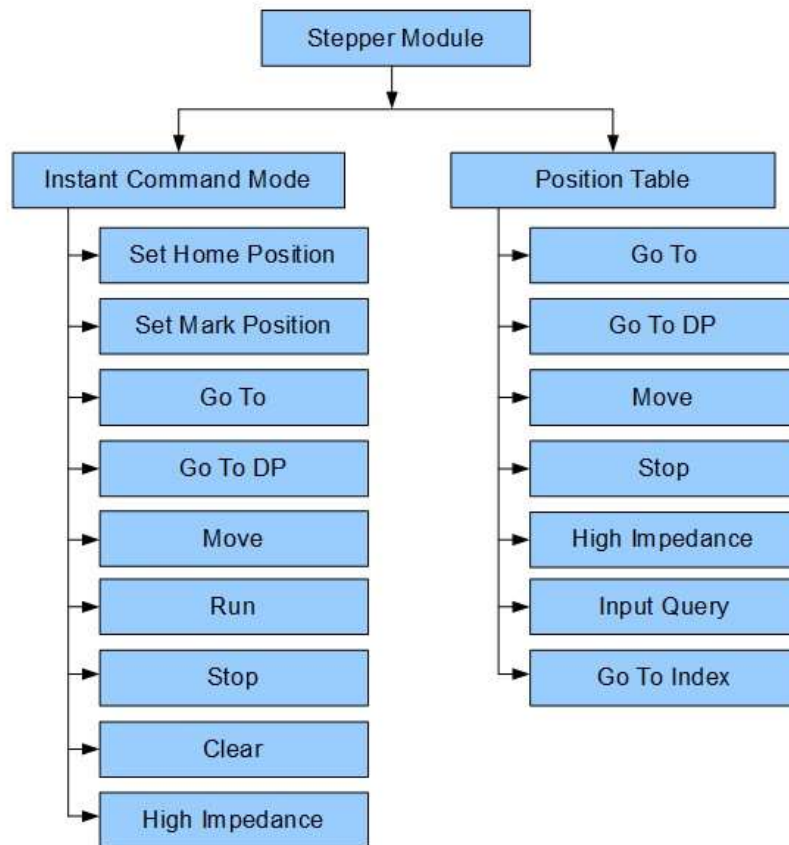

EW62T5521 provides two main function commands.

After power on, module will be ready and motor is neutral position(not stopped).

Usually, EW62T5521 is on 'Instant Command mode' which is activate function command from master(). If ❶ function command(from master) of EW62T5521 is done(), EW62T5521 is stay last command status and hold ❷ on position(). ❸ ex

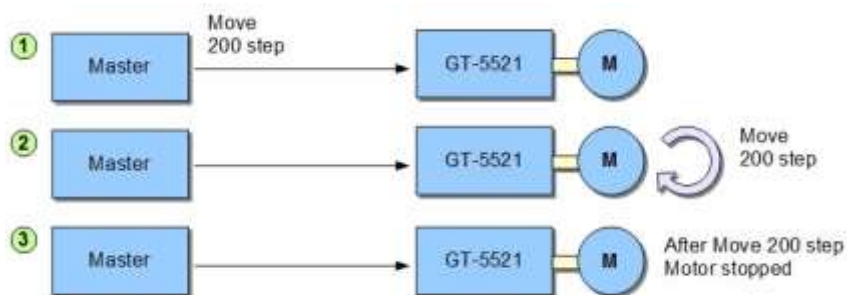

In 'Position Table Mode', module needs some specific commands. In this manual, it will be covered in the 'How to use position table function.' chapter.

Specification

2.4. LED Indicator

2.4.1. Channel Status LED

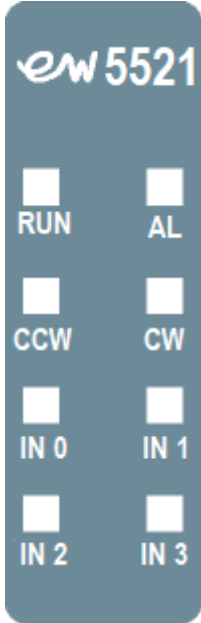
Module Win. Label	LED	Color	Status	Description
	RUN	Green	Off	Module supply not connected.
			Blinking	Motor is at constant speed. Absolute positioning or motion command is under execution.
			On	Motor Normal Operation.
	AL *	Green	On	Alarm occurred.
			Off	No Alarm.
	CCW	Green	On	Motor is rotating counter clockwise.
			Off	Motor is stopped.
	CW	Green	On	Motor is rotating clockwise.
			Off	Motor is stopped.
	IN 0	Green	On	Input 0 is ON.
			Off	Input 0 is OFF.
	IN1	Green	On	Input 1 is ON.
			Off	Input 1 is OFF.
	IN2	Green	On	Input 2 is ON.
			Off	Input 2 is OFF.
	IN3	Green	On	Input 3 is ON.
			Off	Input 3 is OFF.

Specification

***Note : At least one of the following conditions occurs:**

- Overcurrent detection

Specification

2.5. Configuration Parameter Data

This section describes the individual parameters that shall be used to configure the EW62T5521 Stepper module:

No.	Name	Description	Type
1	Acceleration Current (in peak current)	Target phase current generated by controlling the amplitude of motor supply voltage that is assigned to the module. It should be configured with HiZ state. If motor status is not, it will be HiZ State. $(7.8 \times \text{Value}) / 100 = \text{Setting Current(A)}$	Byte
2	Deceleration Current (in peak current)	Target phase current generated by controlling the amplitude of motor supply voltage that is assigned to the module. It should be configured with HiZ state. If motor status is not, it will be HiZ State. $(7.8 \times \text{Value}) / 100 = \text{Setting Current(A)}$	Byte
3	Holding Current (in peak current)	Target phase current generated by controlling the amplitude of motor supply voltage that is assigned to the module. It should be configured with HiZ state. If motor status is not, it will be HiZ State. $(7.8 \times \text{Value}) / 100 = \text{Setting Current(A)}$	Byte
4	Running Current (in peak current)	Target phase current generated by controlling the amplitude of motor supply voltage that is assigned to the module. It should be configured with HiZ state. If motor status is not, it will be HiZ State. $(7.8 \times \text{Value}) / 100 = \text{Setting Current(A)}$	Byte
5	Step mode & Encoder/Digital Input selection	This byte contains Step mode select(4~7bit) and Encoder/Digital input selection(0~3bit). Step mode range = Full step ~ 1/16 micro step. Digital Input, Encoder mode(AB mode).	Byte
6	Acceleration Speed	The available range is from 14.55 to 59590 step/s ² with a resolution of 14.55 step/s ² . When the value is set to 59590, the device works in infinite acceleration mode.	Float*
7	Deceleration Speed	The available range is from 14.55 to 59590 step/s ² with a resolution of 14.55 step/s ² . When the device is working in infinite acceleration mode, this value is ignored.	Float*
8	Maximum Speed	The available range is from 15.25 to 15610 step/s with a resolution of 15.25 step/s.	Float*
9	Minimum Speed	The available range is from 0 to 976.3 step/s with a resolution of 0.238 step/s. Note: If the Minimum Speed is set to '0' then the Module will enable Low Speed Optimization in order to achieve smooth operation at lower speeds.	Float*
10	Full Step Speed	Defines the threshold speed for the step mode to Switch automatically to full step mode. When the motor speed exceeds this threshold value, the full step mode is automatically switched to full-step. The available range is from 7.63 to 15625 step/s with a resolution of 15.25 step/s.	Float*

* Float type :

ex) Maximum speed = 2008.16 step/sec

Configuration parameter of Maximum speed = 200816 → 0x31070

(* WH: writable only when outputs are in high impedance

Byte	Bit7	Bit6	Bit5	Bit4	Bit3	Bit2	Bit1	Bit0	Remarks(*)
0	Acceleration Current								WH

Specification

1	Deceleration Current								WH	
2	Holding Current								WH	
3	Running Current								WH	
4	Step mode & Encoder/Digital Input selection									
	Step mode				Enc/DI select					WH
	Full Step	0	0	0	Digital Input	0	0	0		
	1/2 Step	0	0	1		0	0	0		
	1/4 Step	0	1	0	Encoder (AB mode)	0	0	1		
	1/8 Step	0	1	1		0	0	1		
1/16 Step	1	0	0							
5	Accelation Speed Parameter 0(Low)								WH	
6	Accelation Speed Parameter 1(Low)								WH	
7	Accelation Speed Parameter 2(High)								WH	
8	Accelation Speed Parameter 3(High)								WH	
9	Deceleration Speed Parameter 0(Low)								WH	
10	Deceleration Speed Parameter 1(Low)								WH	
11	Deceleration Speed Parameter 2(High)								WH	
12	Deceleration Speed Parameter 3(High)								WH	
13	Maximum Speed Parameter 0(Low)								WH	
14	Maximum Speed Parameter 1(Low)								WH	
15	Maximum Speed Parameter 2(High)								WH	
16	Maximum Speed Parameter 3(High)								WH	
17	Minimum Speed Parameter 0(Low)								WH	
18	Minimum Speed Parameter 1(Low)								WH	
19	Minimum Speed Parameter 2(High)								WH	
20	Minimum Speed Parameter 3(High)								WH	
21	Full Step Speed Parameter 0(Low)								WH	
22	Full Step Speed Parameter 1(Low)								WH	
23	Full Step Speed Parameter 2(High)								WH	

Specification

24	Full Step Speed Parameter 3(High)	WH
----	-----------------------------------	----

2.6. Mapping data into the image table

● Input Image Value (16 Byte)

Byte	Input Image Data							
	Bit 7	Bit 6	Bit 5	Bit 4	Bit 3	Bit 2	Bit 1	Bit 0
Module Status Input Data								
0	HiZ	Busy	M_DIR	-	-	-	F_POW	Ready (Module_OK)
1	--	--	--	--	CMD_STATUS		MOT_STATUS	
2	Pos Tab Read	Command Data						
3	Position Table Index							
Absolute Position Input Data/Position table Read data								
4	Absolute Position Input 0 byte							
Position Command Parameter1								
5	Absolute Position Input 1 byte							
Position Command Parameter2								
6	Absolute Position Input 2 byte							
7	Absolute Position Input 3 byte							
Actual Speed Input Data/Position table Read data								
8	Actual Speed Input 0							
Position Command Parameter3								
9	Actual Speed Input 1							
Position Command Parameter3								
10	Actual Speed Input 2							
Position Command Parameter3								
11	Actual Speed Input 3							
Position Command Parameter3								
Digital Input /Encoder Position Input Data								
12	--							DI 0
Encoder Position Input 0 byte								
13	--							DI 1
Encoder Position Input 1 byte								
14	--							DI 2

Specification

	Encoder Position Input 2 byte
15	--
	Encoder Position Input 3 byte

* This counter is a cyclic 16-bit counter. The relationship between this counter and the internal position counter depends on the resolution of the encoder and the microsteps defined for the internal position counter.

● Output Image Value (10 Byte)

Byte	Output Image Data							
	Control Word 0							
	Bit 7	Bit 6	Bit 5	Bit 4	Bit 3	Bit 2	Bit 1	Bit 0
Module Output Mode								
0	--		Pos Tab Read	Pos Tab Run	Pos Tab Save	Pos Tab Write	Instant Command	
1	Position Table Index							
Command Data								
2	NOP			0	0	0	0	
	SET_HOME_POSITION			0	0	0	1	
	SET_MARK_POSITION			0	0	1	0	
	GOTO			0	0	1	1	
	GOTO_DP			0	1	0	0	
	MOVE			0	1	0	1	
	RUN			0	1	1	0	
	INPUT_QUERY*			0	1	1	1	
	STOP			1	0	0	0	
	GOTO_INDEX			1	0	0	1	
CLEAR			1	0	1	0		
High Impedance			1	0	1	1		
Command Parameter Data								
3	Direction (Reverse : 0 / Forward : 1)						Dir	
	State Change (On -> Off : 0 / Off -> On : 1)						Input Query	
4	Stop Mode (Soft Stop : 0 / Hard Stop : 1)						Stop	
	Position (Home : 0 / Mark : 1 / Absolute : 2)						GOTO	
5	SPD & POS Output 0 / *Position Table No.							
6	SPD & POS Output 1 / *Position Table No.							
7	SPD & POS Output 2 / *Position Table No.							

Specification

8	SPD & POS Output 3 / *Position Table No.
	Reserved
9	Reserved

* Since the initial state of the motor is in the high impedance state, it is recommended to change to the STOP operation state before other operations.

- * Position Table Index is only for 'Position Table Function'.
- * INPUT_QUERY, GOTO_INDEX is only for 'Position Table Function'.

* 'State Change' is only for INPUT_QUERY.

* 'Position Table No.' is only for GOTO_INDEX.

2.7. Application Commands

This section describes the output command modes and individual commands of the stepper module in detail.

EW62T5521 has two main output mode. 'Instant command mode' and 'Position Table Mode'. It executes only one module output mode at once.

Following tabel summarizes the list of module output modes:

1. Mode: Instant Command

Description: With this mode, module instantly execute the command, which is received from Network Adpater.

Following table summarizes the list of supported commands:

1.1 Command: NOP

Description: No action is taken by the module. If this command use in position table function command, it will be used as wait command.

Command Structure:

Command Value	Parameters (Data Type)	Description
0x00	Byte / Enumeration.	Op-code for NOP Command.
-	Byte / Enumeration.	This parameter is ignored by the module.
-	Byte / Enumeration.	This parameter is ignored by the module.
- Wait Count (only position table)	32-bit Integer	32-bit unsigend integer value. This parameter contains waiting count value.

Example Command Code :

Output Byte	Output Mode		Cmd	Cmd Parameter Data						Reserv ed
	0	1		Para1	Para2	Para3				
	0	1	2	3	4	5	6	7	8	9
Instant Cmd/ Set Home	01	00	01	00	00	00	00	00	00	00

1.2 Command: Set Home Position

Description: This command resets the internal position register to zero. The zero position is also defined as HOME position.

With Encoder Interface mode, this command initialize encoder count.

Command Structure:

Specification

Command Value	Parameters (Data Type)	Description
0x01	Byte / Enumeration.	Op-code for Set Home Position Command.
-	Byte / Enumeration.	This parameter is ignored by the module.
-	Byte / Enumeration.	This parameter is ignored by the module.
-	32-bit Integer	This parameter is ignored by the module.

Example Command Code :

Output Byte	Output Mode		Cmd	Cmd Parameter Data						Reserv ed
	0	1		Para1	Para2	Para3				
Instant Cmd/ Set Home	01	00	01	00	00	00	00	00	00	00

1.3 Command: Set Mark Position

Description: This command sets the new value for the mark position.

Command Structure:

Command Value	Parameters (Data Type)	Description
0x02	Byte / Enumeration.	Op-code for Set Mark Position Command.
-	Byte / Enumeration.	This parameter is ignored by the module.
-	Byte / Enumeration.	This parameter is ignored by the module.
Position	32-bit Integer	32-bit Integer Value. New position to be loaded in the MARK register.

Example Command Code : Set Marked Position 200 step

Output Byte	Output Mode		Cmd	Cmd Parameter Data						Reserv ed
	0	1		Para1	Para2	Para3				
Instant Cmd/ Set Home	01	00	02	00	00	C8	00	00	00	00

1.4 Command: GOTO

Description: This command produces a motion to the specified Home / Mark / Absolute position through the shortest path. The Absolute position (output scan) value is always in agreement with the selected step mode; the parameter value unit is equal to the selected step mode (full, half, quarter etc.). This command keeps the BUSY flag low until the target position is reached. This command can be given only when the previous motion command has been completed (BUSY flag released). Any attempt to perform this command when a previous command is under execution (BUSY low) causes the command to be ignored.

Command Structure:

Command Value	Parameters (Data Type)	Description
0x03	Byte / Enumeration.	Op-code for GOTO Command.
-	Byte / Enumeration.	This parameter is ignored by the module.
Home/Mark / Absolute Position	Byte / Enumeration.	The options 'Home position - 0 / Mark position - 1' uses the values from the

Specification

		internal registers. So, the third parameter is only used with 'Absolute Position - 2'.
Position	32-bit Integer	32-bit Integer Value. This parameter is used with the option 'Absolute Position' otherwise it will be ignored by the module

Example Command Code : Goto Home/Go to Set/Go to Abs 51,200 steps

	Output Mode		Cmd	Cmd Parameter Data						Reserv ed
	0	1		Para1	Para2	Para3				
Output Byte	0	1	2	3	4	5	6	7	8	9
Instant Cmd/ GOTO Home	01	00	03	00	00	00	00	00	00	00
Instant Cmd/ GOTO Set	01	00	03	00	01	00	00	00	00	00
Instant Cmd/ GOTO Abs	01	00	03	00	02	00	C8	00	00	00

1.5 Command: GOTO_DP

Description: This command produces a motion to the specified absolute position imposing a forward or a reverse direction. The Absolute Position (output scan) value is always in agreement with the selected step mode; the parameter value unit is equal to the selected step mode (full, half, quarter, etc.).

This command keeps the BUSY flag low until the target speed is reached. This command can be given only when the previous motion command has been completed (BUSY flag released). Any attempt to perform this command when a previous command is under execution (BUSY low) causes the command to be ignored.

Command Structure:

Command Value	Parameters (Data Type)	Description
0x04	Byte / Enumeration.	Op-code for GOTO_DP Command.
Direction	Byte / Enumeration.	This parameter specifies the direction of rotation –either Reverse – 0 / Forward – 1 to be used with the command.
-	Byte / Enumeration.	This parameter is ignored by the module.
Position	32-bit Integer	32-bit Integer Value. This parameter contains the absolute position to be used by the command

Example Command Code : Goto DP Forward / Goto DP Reverse

	Output Mode		Cmd	Cmd Parameter Data						Reserv ed
	0	1		Para1	Para2	Para3				
Output Byte	0	1	2	3	4	5	6	7	8	9
Instant Cmd/ GOTO DP FW	01	00	04	01	00	00	00	00	00	00
Instant Cmd/ GOTO DP REV	01	00	04	00	00	00	C8	00	00	00

Specification

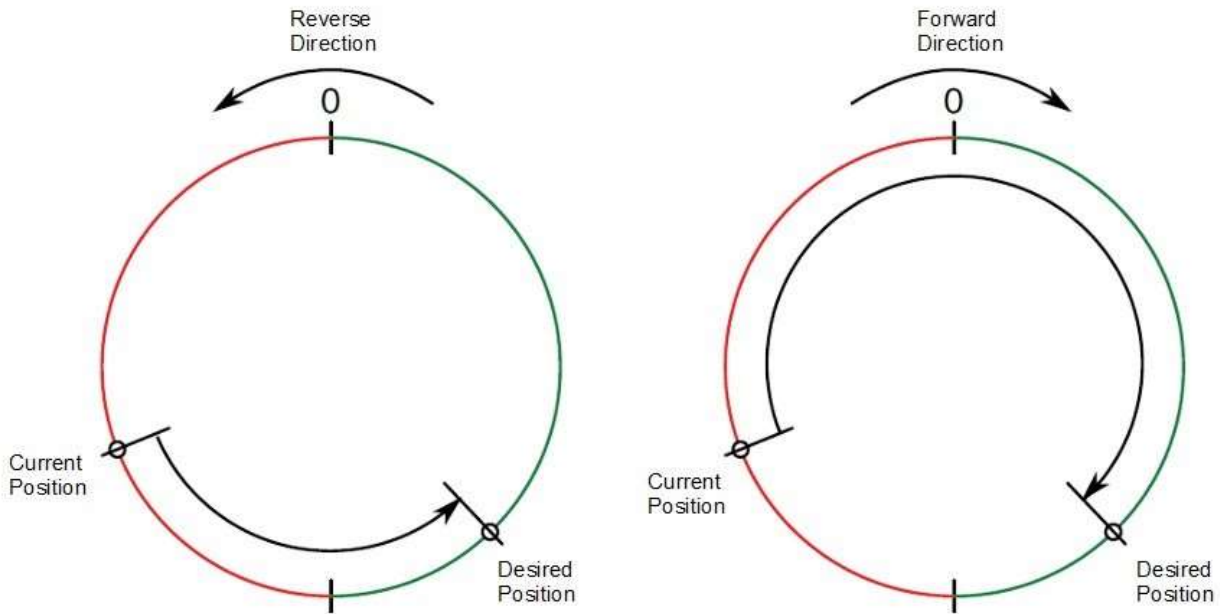

* Caution : GOTO DP command has direction of motor movement. Thus, motor doesn't work the shortest way to desired position(in absolute position).

1.6. Command: MOVE

Description: This command produces a motion of 'N' micro steps specified by the third parameter; the direction is specified by the first parameter (forward or reverse). The value of 'N' is always in agreement with the selected step mode (full, half, quarter, etc.).

This command keeps the module BUSY until the target number of steps are performed. This command can only be performed when the motor is stopped. If a motion is in progress, the motor must be stopped and it is then possible to perform a Move command. Any attempt to perform a Move command when the motor is running causes the command to be ignored.

Command Structure:

Command Value	Parameters (Data Type)	Description
0x05	Byte / Enumeration.	Op-code for MOVE Command.
Direction	Byte / Enumeration.	This parameter specifies the direction of rotation –either Reverse – 0 / Forward – 1 to be used with the command.
-	Byte / Enumeration.	This parameter is ignored by the module.
N-Micro Steps	32-bit Integer	32-bit Integer Value. This parameter contains the value of micro steps to be used by the command.

Note:

1. If the specified speed is lower than the configured Minimum Speed than the motor attains the target speed starting from zero to allow smooth operation of the motor.

Example Command Code : Move Forward 51,200 step / Move Reverse 51,200 step

Output Byte	Cmd Parameter Data									
	Output Mode	Cmd	Para1	Para2	Para3				Reserv ed	
	0	1	2	3	4	5	6	7	8	9
Instant Cmd/ GOTO DP FW	01	00	05	01	00	00	C8	00	00	00
Instant Cmd/ GOTO DP REV	01	00	05	00	00	00	C8	00	00	00

Specification

1.7. Command: RUN

Description: This command produces a motion at the speed specified by the third parameter; the direction is specified by the first parameter (forward or reverse). The value of speed is expressed in steps/sec. The specified speed value should be lower than Maximum Speed and greater than Minimum Speed (provided in module configuration) otherwise the Run command is executed at Maximum Speed or Minimum Speed respectively.

This command keeps the module BUSY until the target speed is reached. This command can be given anytime and is immediately executed.

Note:

1. If the specified speed is lower than the configured Minimum Speed than the motor attains the target speed starting from zero to allow smooth operation of the motor.

Command Structure:

Command Value	Parameters (Data Type)	Description
0x06	Byte / Enumeration.	Op-code for RUN Command.
Direction	Byte / Enumeration.	This parameter specifies the direction of rotation –either Reverse – 0 / Forward – 1 to be used with the command.
-	Byte / Enumeration.	This parameter is ignored by the module.
Speed	32-bit Integer	32-bit Integer Value. This parameter contains the value of Speed in steps/sec to be used by the command.

Example Command Code : Run Forward 1,000 step per sec / Run Reverse 1,000 step per sec

	Output Mode		Cmd	Cmd Parameter Data						Reserv ed
	0	1		Para1	Para2	Para3				
Output Byte	0	1	2	3	4	5	6	7	8	9
Instant Cmd/ GOTO DP FW	01	00	06	01	00	E8	03	00	00	00
Instant Cmd/ GOTO DP REV	01	00	06	00	00	E8	03	00	00	00

1.8. Command: INPUT_QUERY

Description: This Command is not executed in instant command mode, it is only for Position table function command.

'INPUT_QUERY' function is that check the change of input channel status. If input channel's condition is as same as user-defined condition, module proceed next position table function. If it is not, stay until it is satisfying.

Command Structure:

Command Value	Parameters (Data Type)	Description
0x07	Byte / Enumeration.	Op-code for Input_Query Command.
-	Byte / Enumeration.	This parameter is ignored by the module.
Status Change Check Mode	Byte / Enumeration.	This parameter specifies the method of status change check mode (Off -> On – 1/ On -> Off – 0) used with this command.
-	32-bit Integer	This parameter is ignored by the module.

Example Command Code :

1. Index 6 : Digital Input Ch1 On → Off?
2. Index 4 : Digital Input Ch2 Off → On?

	Output Mode	Cmd	Cmd Parameter Data						Reserv ed
--	-------------	-----	--------------------	--	--	--	--	--	-----------

Specification

Output Byte	0		1		2		Para1	Para2	Para3			9
	0	1	2	3	4	5	6	7	8	9		
Pos Write/ Input Query Ch1, Off -> On On Index 6	02	06	07	00	00	01	00	00	00	00	00	
Pos Write/ Input Query Ch2, On -> Off On Index 4	02	04	07	01	00	02	00	00	00	00	00	

1.9. Command: STOP

Description: This command causes the motor to stop. The first parameter specifies the stop method to be used with this command and it can be either with infinite deceleration (Hard stop) or immediate deceleration to zero speed and a consequent motor stop (Soft stop)

This command can be given anytime and is immediately executed. This command keeps the module BUSY until the motor is stopped.

Command Structure:

Command Value	Parameters (Data Type)	Description
0x08	Byte / Enumeration.	Op-code for STOP Command.
-	Byte / Enumeration.	This parameter is ignored by the module.
Stop Mode	Byte / Enumeration.	This parameter specifies the method of stop mode (Soft stop – 0 / Hard stop – 1) used with this command.
-	32-bit Integer	This parameter is ignored by the module.

Example Command Code :

Output Byte	0		1		2		Cmd Parameter Data			Reserv ed
	0	1	2	3	4	Para3				
Instant Cmd/ Soft Stop	01	00	08	00	00	00	00	00	00	00
Instant Cmd/ Hard Stop	01	00	08	00	01	00	00	00	00	00

1.10. Command: GOTO_INDEX

Description: This Command is not executed in instant command mode. This is able to change of current position table index while position table program is running.

Command Structure:

Command Value	Parameters (Data Type)	Description
0x0A	Byte / Enumeration.	Op-code for GOTO Index Command.
-	Byte / Enumeration.	This parameter is ignored by the module.
-	Byte / Enumeration.	This parameter is ignored by the module.
- Position Table Index No.	32-bit Integer	This parameter specifies the desired index number to change.

Example Command Code :

On Index no. 11 : Goto Index no. 7

Output Byte	0		1		2		Cmd Parameter Data			Reserv ed
	0	1	2	3	4	Para3				

Specification

Pos Write/ Goto Index On index 11	02	0B	09	00	00	07	00	00	00	00
---	----	----	----	----	----	----	----	----	----	----

1.11. Command: CLEAR

Description: This command clears any warnings / alarms flags internally maintained by the module and forces the module to exit from any error state.

Command Structure:

Command Value	Parameters (Data Type)	Description
0x0A	Byte / Enumeration.	Op-code for CLEAR Command.
-	Byte / Enumeration.	This parameter is ignored by the module.
-	Byte / Enumeration.	This parameter is ignored by the module.
-	32-bit Integer	This parameter is ignored by the module.

Example Command Code :

	Output Mode		Cmd	Cmd Parameter Data						Reserv ed
	0	1		Para1	Para2	Para3				
Output Byte	0	1	2	3	4	5	6	7	8	9
Instant Cmd/ Soft Stop	01	00	0A	00	00	00	00	00	00	00

1.12. Command: High Impedance

Description: This command causes the motor to stop and Power bridge will be disabled. The first parameter specifies the stop method to be used with this command and it can be either with infinite deceleration (Hard stop and Impedance) or immediate deceleration to zero speed and a consequent motor stop (Soft stop and Impedance).

This command can be given anytime and is immediately executed. This command keeps the module BUSY until the motor is stopped and power bridge is disabled.

Command Structure:

Command Value	Parameters (Data Type)	Description
0x0B	Byte / Enumeration.	Op-code for High Impedance Command.
-	Byte / Enumeration.	This parameter is ignored by the module.
Impedance Mode	Byte / Enumeration.	This parameter specifies the method of High Impedance mode (Soft HiZ – 0 / Hard HiZ – 1) used with this command.
-	32-bit Integer	This parameter is ignored by the module.

Example Command Code :

	Output Mode		Cmd	Cmd Parameter Data						Reserv ed
	0	1		Para1	Para2	Para3				
Output Byte	0	1	2	3	4	5	6	7	8	9
Instant Cmd/ Soft Stop	01	00	0B	00	00	00	00	00	00	00
Instant Cmd/ Hard Stop	01	00	0B	00	01	00	00	00	00	00

Specification

2. Mode: Position Table mode

Position Table mode has several command. Each commands are for position table function. Position commands are consist of 'Write', 'Save', 'Run', 'Read'. EW62T5521 execute only one function command at once.

2.1. Position Table Write

Description: This mode is for create 'Position Table' of EW62T5521.

With this mode, EW62T5521 make a Position Table List.

EW62T5521 provides 250 position table list. Table creation procedure is as following below :

1. Define maximum index of position table.

Example Command Code : Create position table(Maximum index size 12)

	Output Mode		Cmd	Cmd Parameter Data						Reserv ed
	0	1		Para1	Para2	Para3				
Output Byte	0	1	2	3	4	5	6	7	8	9
Pos Write/ Table Create Index 12	02	FB	00	00	00	0C	00	00	00	00

1.1 If you **initialize table list**, set the maximum index to 0xFF.

Example Command Code : Initialize position table(= Maximum index size 0)

	Output Mode		Cmd	Cmd Parameter Data						Reserv ed
	0	1		Para1	Para2	Para3				
Output Byte	0	1	2	3	4	5	6	7	8	9
Pos Write/ Table Initialize	02	FF	00	00	00	00	00	00	00	00

2. Write command on each position table list.

Example Command Code : Write on position table index 0, reverse 3200 step move

	Output Mode		Cmd	Cmd Parameter Data						Reserv ed
	0	1		Para1	Para2	Para3				
Output Byte	0	1	2	3	4	5	6	7	8	9
Pos Table Run	08	00	00	00	00	00	00	00	00	00

	Output Mode		Cmd	Cmd Parameter Data						Reserv ed
	0	1		Para1	Para2	Para3				
Output Byte	0	1	2	3	4	5	6	7	8	9
Pos Write/ CW 3200 step On Index 0	02	00	05	01	00	80	0C	00	00	00

2.2 Position Table Save

Description: This mode is for save 'Position Table' of EW62T5521.

When 'Position Table Write' procedure is finished, 'Position Table Save' is necessary.

In addition, it should be executed, before 'Position Table Run'.

Example Command Code : Position Table Save

	Output Mode		Cmd	Cmd Parameter Data						Reserv ed
	0	1		Para1	Para2	Para3				
Output Byte	0	1	2	3	4	5	6	7	8	9
Pos Table Save	04	00	00	00	00	00	00	00	00	00

2.3 Position Table Run

Description: Position Table Mode activated by this command.

Specification

Example Command Code : Position Table Run

2.4 Position Table Read

Description: With this mode, user can observe the Position Table List.

Each specific position table function command on list will be indicated at input data.

Example Command Code : Position Table Read (Index no.1 of position table list)

Output Byte	Output Mode		Cmd	Cmd Parameter Data						Reserved
	0	1		Para1	Para2	Para3			8	
Pos Table Read/ Index 1	10	00	00	00	00	01	00	00	00	00

Specification

2.8. How to use position table function.

This section describes how to use position table function of EW62T5521.

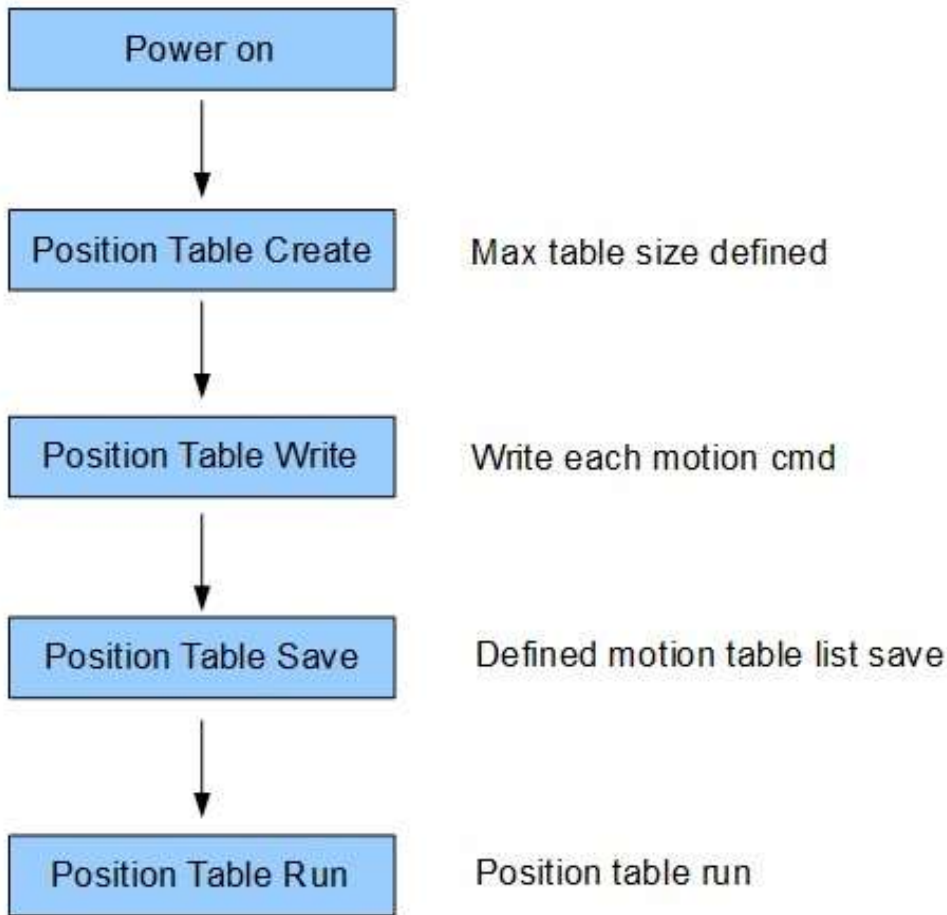

- If 'Position Table Write' function is executed, 'Position Table Run' function won't be executed before 'Position Table Save' function is activated. Please activate

The example command is following below :

1. Position Table Create(define maximum table size)

Example Command Code : Create position table(Maximum index size 12)

	Output Mode		Cmd	Cmd Parameter Data						Reserv ed
	0	1		Para1	Para2	Para3				
Output Byte	0	1	2	3	4	5	6	7	8	9
Pos Write/ Table Create Index 10	02	FB	00	00	00	0A	00	00	00	00

2. EW62T5521 create position table list as give command.

	Output Mode	Cmd	Cmd Parameter Data						Reserved
			Para1	Para2	Para3				

Specification

index no.	0	1	2	3	4	5	6	7	8	9
0										
1										
2										
3										
4										
5										
6										
7										
8										
9										

3. Enter each desired Position table command, until fill the position table list.

Example Command : Move to 3200 step position on absolute position axis (Index 0)

index no.	Output Mode		Cmd	Cmd Parameter Data						Reserved
				Para1	Para2	Para3				
	0	1	2	3	4	5	6	7	8	9
0	02	00	03	00	02	80	0C	00	00	00
1										
2										
3										
4										
5										
6										
7										
8										
9										

4. If 'Position Table Write' procedure is finished, please command 'Position Table Save'

Example Command : Position Table Save

Description	Output Mode		Cmd	Cmd Parameter Data						Reserved
				Para1	Para2	Para3				
	0	1	2	3	4	5	6	7	8	9
Pos Table Save	04	00	00	00	00	00	00	00	00	00

5. Run Position table list.

Example Command : Position Table Run

Output Mode	Cmd	Cmd Parameter Data						Reserved
-------------	-----	--------------------	--	--	--	--	--	----------

Specification

Description				Para1	Para2	Para3				
	0	1	2	3	4	5	6	7	8	9
Pos Table Run	08	00	00	00	00	00	00	00	00	00

2.8.1. Position Table Run

Once run 'Position Table Run', EW62T5521 will be performed function command following position table list. If module is performed final function command on position table list, the module goes to perform first function command on the position table list.

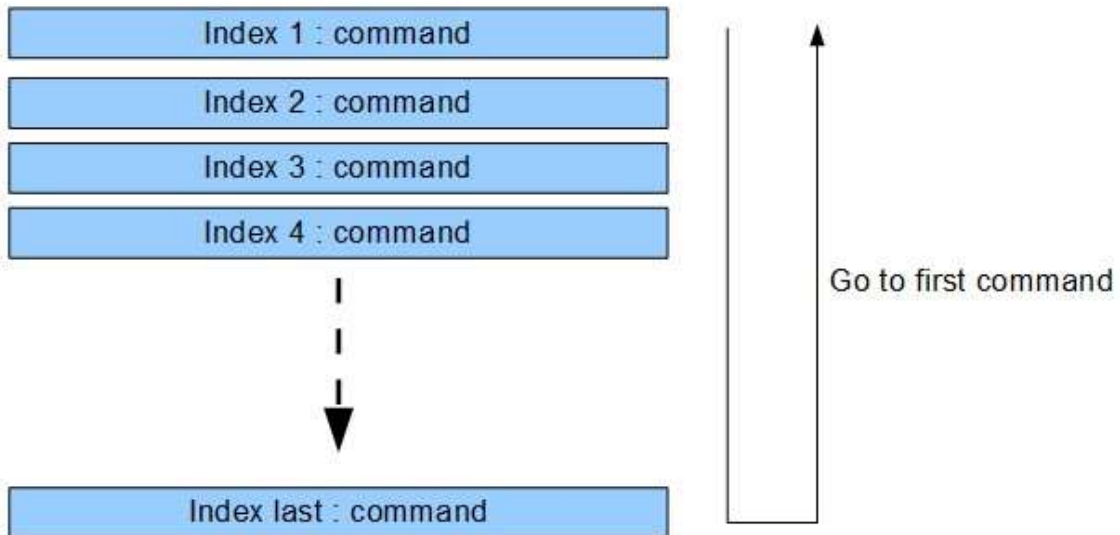

If you want module keep position table run mode, give any command after 'Position Table Run command' or EW62T5521 will be stopped.

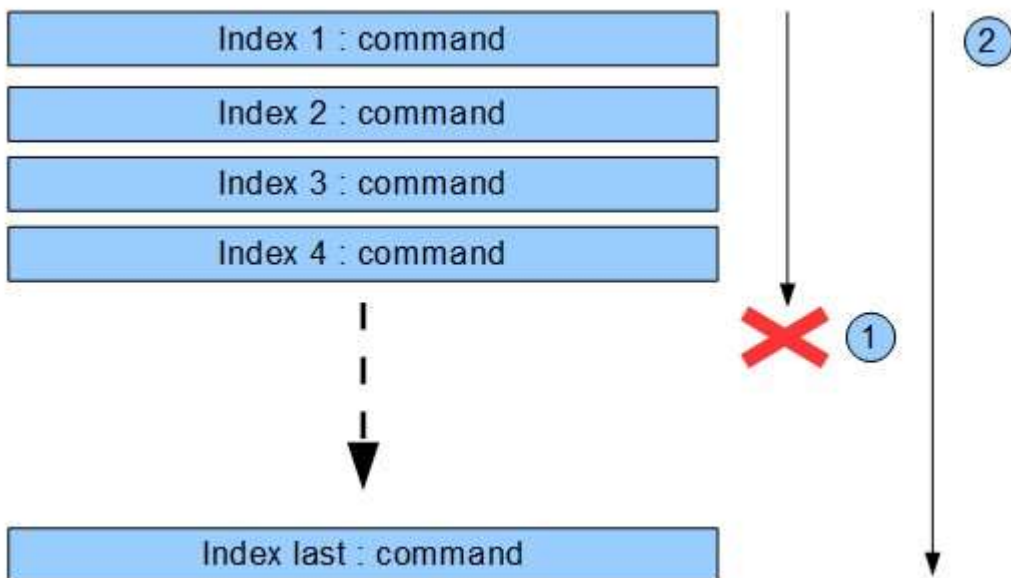

If module is stopped() and come back to 'Position Table Run mode', module will be start at first function ① command on the position table list(). ②